

# Actuator

31-  
051.006

Distribution by  
Mouser



Your product:

---



## 31-051.006 Actuator

*Loading ...*

### PRODUCT RANGE

**Product Status:** Not Recommended for new design

### FRONT

**Front dimension:** 18 mm x 18 mm

**Front form:** Square

**Front bezel colour:** Black

**Front bezel material:** Plastic

### MOUNTING

**Design:** Raised

**Mounting cut-out:** Ø 16 mm

**Mounting type:** Panel mounting

### MECHANICAL CHARACTERISTICS

**Terminal:** Universal terminal, 2 x 0.5 mm

**Weight:** 0.005 kg

### CERTIFICATE

**REACH:** REACH compliant

**RoHS:** RoHS compliant

### OTHER

**Short Description:**

Actuator, Ø 16 mm, 18 mm x 18 mm, Square, Black, Plastic, Universal terminal, 2 x 0.5 mm

**Internal size:**

15,3 mm x 15,3 mm

**Housing colour:**

Black

**Housing material:**

Plastic

**Wiring diagrams:**

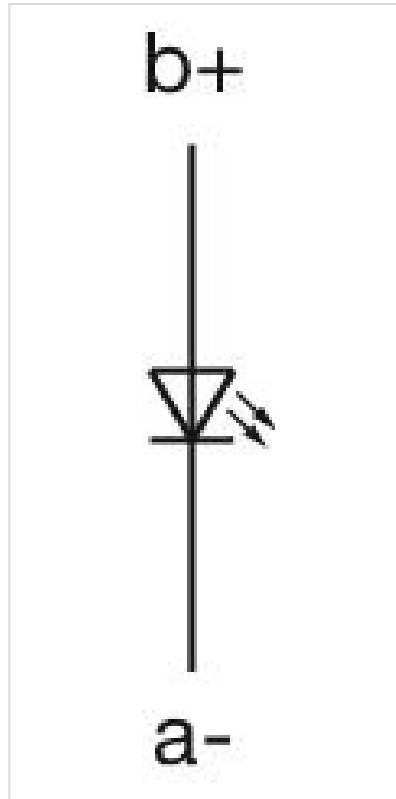

**Component layouts:**

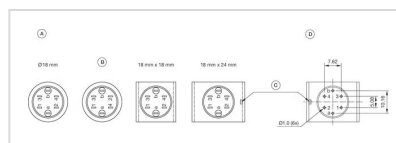

- A = Terminals (rear side)
- B = Diode block
- C = Anti twist device only 18 mm x 24 mm
- D = Drilling plan (component side)

**Mounting cut-outs:**

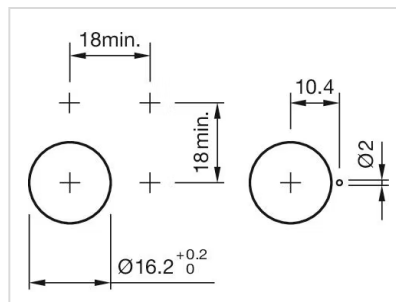

**Dimension drawings:**

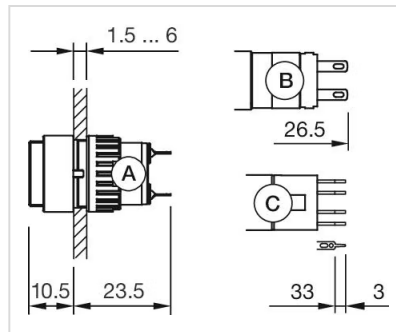

- A = Solder terminal
- B = Plug-in terminal 2.8 mm x 0.5 mm
- C = Universal terminal 2.0 mm x 0.5 mm