

Lamp block

704.950.1/D

Distribution by
Mouser



<https://mouser.eao.com/component/704.950.1/D/...>

Your product:



704.950.1/D Lamp block

Loading ...

ELECTRICAL CHARACTERISTICS

Standards: The switches comply with the "Standards for low-voltage switching devices" DIN EN 60947-1/DIN EN 60947-5-1

MECHANICAL CHARACTERISTICS

Terminal: Double plug-in terminal, 6.3 x 0.8 mm
Switching positions: 2 positions
Wire cross section: Double plug-in terminal 2 x 6.3 mm x 0.8 mm
Weight: 0.013 kg

AMBIENT CONDITION

IP Protection: IP00
Operating temperature: - 40 °C ... + 55 °C
Storage temperature: - 40 °C ... + 85 °C
Shock resistance: Max. 300 m/s², pulse width 11 ms (sinusoidal EN IEC 60068-2-27)
Vibration resistance: Max. 100 m / s² from 10 Hz ... 500 Hz, (sinusoidal EN IEC 60068-2-6)
Climate resistance: Relative humidity, max. 95%, non-condensing

CERTIFICATE

REACH: REACH compliant
RoHS: RoHS compliant

OTHER

Short Description: Lamp block, Plastic, Double plug-in terminal, 6.3 x 0.8 mm

Housing material:

Plastic

Product attributes:

Terminals nickel plated and blank Cu/Sn

Hints:

When using the lamp block, the application guidelines must be observed.

Wiring diagrams:

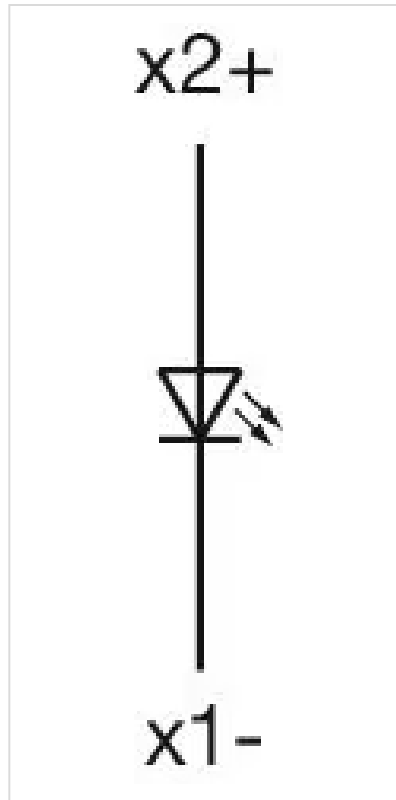

Dimension drawings:

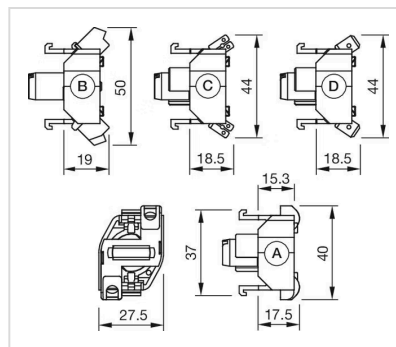

- A = Screw terminal
- B = Push-in terminal (PIT)
- C = Plug-in terminal 6.3 mm x 0.8 mm
- D = Double plug-in terminal 6.3 mm x 0.8 mm