

# Actuator

71-  
639.0/D

Distribution by  
Mouser



Your product:



## 71-639.0/D Actuator

Loading ...

### MOUNTING

**Mounting type:** Panel mounting

### ELECTRICAL CHARACTERISTICS

**Switching voltage and switching current:**

Switch rating AC $\cos\phi$ 0,7 ... 0,8 gemäss EN IEC 60947-5-1		
Voltage	250 VAC	
Current	3 A	
Switch rating DC gemäss EN IEC 60947-5-1		
Voltage	24 VDC	250 VDC
Current	3 A	0.5 A

**Surge voltage resistance:** 2500 VAC, 50 Hz, 1 minute, as per DIN / IEC 60512-2 between all terminals and earth

**Recommended minimum operational data:**

Voltage	5 VAC/DC
Current	10 mA

### MECHANICAL CHARACTERISTICS

**Switching action:** Maintained (a) - Rest (a) - Momentary

**Switching system:** Self-cleaning, double-break snap action switching system, 1 normally closed and 1 normally open contact per element.

**Switching positions:** 3 positions

**Switching angle:** 90° left / 42° right

**Mechanical lifetime:** 50 000 cycles of operation

**Tightening torque:** Fixing nut max. 0.5 Nm

**Weight:** 0.026 kg

### AMBIENT CONDITION

**IP Protection:** IP65 front side

<b>Operating temperature:</b>	- 25 °C ... + 55 °C
<b>Storage temperature:</b>	- 40 °C ... + 85 °C
<b>Shock resistance:</b>	Max. 500 m/s <sup>2</sup> , pulse width, 3-axis (sinusoidal EN IEC 60068-2-27)
<b>Vibration resistance:</b>	Max. 100 m / s <sup>2</sup> from 10 Hz ... 500 Hz, (sinusoidal EN IEC 60068-2-6)
<b>Climate resistance:</b>	Damp heat, steady: 56 days, + 40 °C/93 % relative humidity, according to EN IEC 60068-2-78

## CERTIFICATE

<b>Conformities:</b>	CE, UKCA, 2011 / 65 / EC (RoHS), 2014 / 35 / EU (LVD)
<b>REACH:</b>	REACH compliant
<b>RoHS:</b>	RoHS compliant

## OTHER

<b>Short Description:</b>	Actuator, Maintained (a) - Rest (a) - Momentary
<b>Housing material:</b>	Plastic, according to UL 94 V0
<b>Product attributes:</b>	Standard lock: DOM 311
<b>Hints:</b>	Standard lock: DOM 311
<b>Switching positions:</b>	

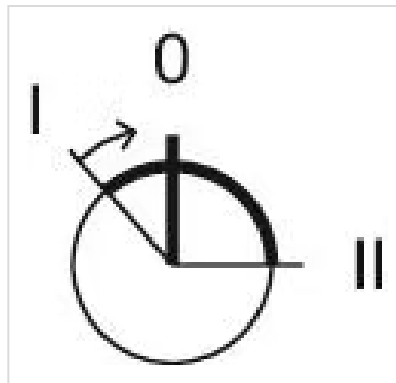

## Wiring diagrams:



## Mounting cut-outs:

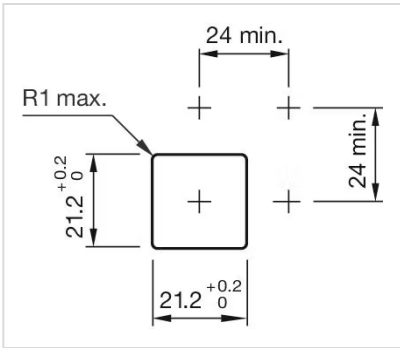
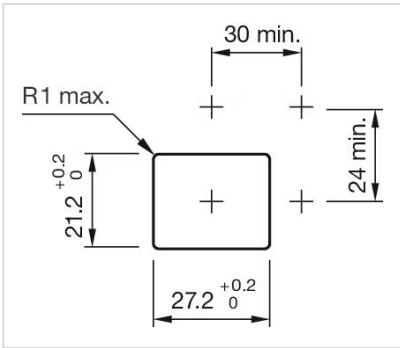
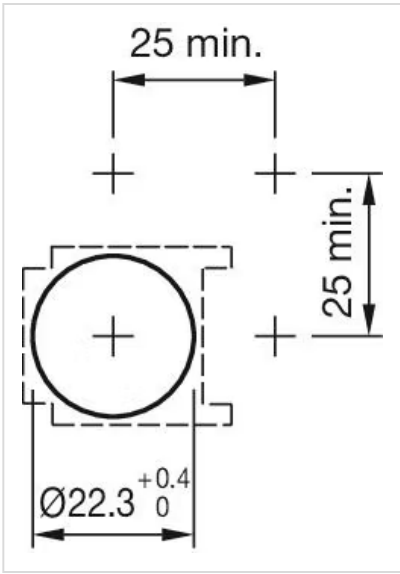

**Dimension drawings:**

