

# Capacitive sensor switch with IO-Link Standard

Distribution by  
Mouser



84-ASKS-B15-04A1



<https://mouser.eao.com/component/84-ASKS-B15-...>

Your product:

---



## 84-ASKS-B15-04A1

### Capacitive sensor switch with IO-Link Standard

*Loading ...*

#### FRONT

**Front dimension:** Ø 30 mm

**Front form:** Round

**Front bezel material:** Plastic

#### MOUNTING

**Design:** Flush

**Mounting cut-out:** Ø 22.5 mm

**Mounting type:** Panel mounting

#### OPERATING-/INDICATION PART

**Lens material:** Plastic

**Lens illumination:** Illuminated

**Lens shape:** Flush

**Lens optics:** transparent

**Symbol:** arrows (B15)

#### ELECTRICAL CHARACTERISTICS

**Operating voltage:** 8.4 - 32 V DC

**Communication interface:** IO-Link specification

#### MECHANICAL CHARACTERISTICS

**Terminal:** Connector M12

**Switching system:** Capacitive  
**Operating force:** No actuating force necessary  
**Weight:** 0.015 kg

#### **AMBIENT CONDITION**

**IP front protection:** IP69K  
**IK front protection:** IK08  
**Operating temperature:** – 30 °C ... + 65 °C  
**Climate resistance:** Relative humidity, max. 95%, non-condensing

#### **CERTIFICATE**

**Approbations:** CSA, EHEDG  
**Conformities:** CE, UKCA  
**REACH:** REACH compliant  
**RoHS:** RoHS compliant

#### **OTHER**

**Short Description:** Capacitive sensor switch with IO-Link Standard, Ø 22.5 mm, Ø 30 mm, Flush, Illuminated, Plastic, transparent, Round, Plastic, Connector M12, IP69K, IK08, arrows (B15)  
**Housing colour:** Black  
**Housing material:** Plastic  
**Wiring diagrams:**

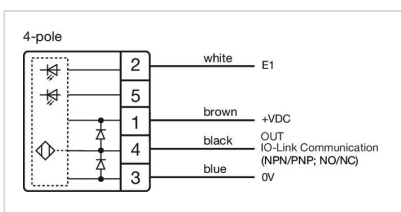
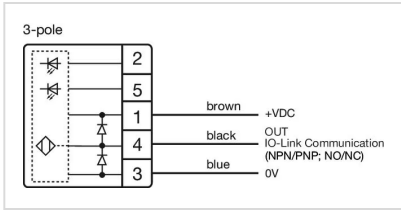
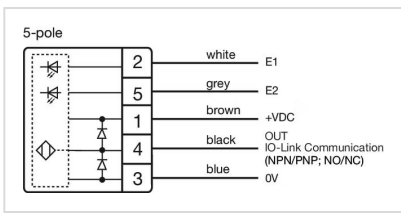

**Component layouts:**

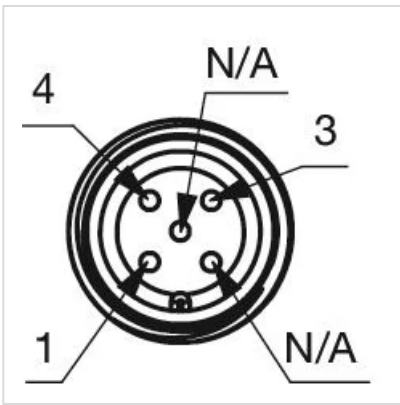
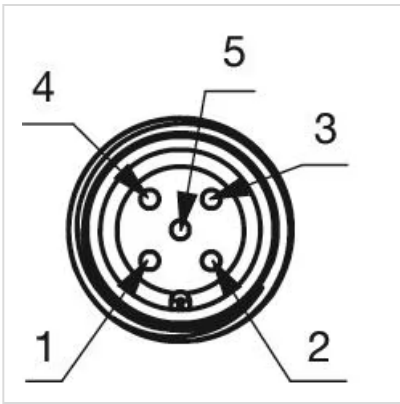
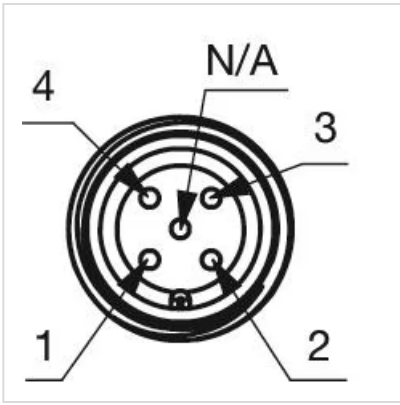

Mounting cut-outs:

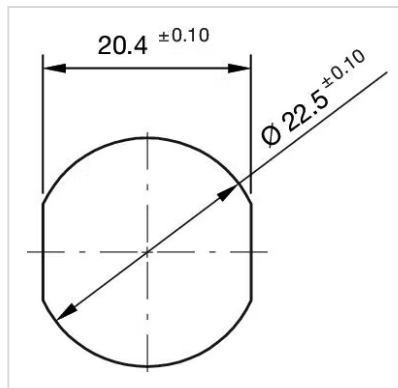

Dimension drawings:

